

# ■ CUBE

## SPITZNAME: CHAMÄLEON.

Ein echter Verwandlungskünstler. Mal aus Aluminium, Edelstahl oder Messing. Mal mit Buche, Kirsch, Schwarz oder Silber. Mal in Klar-, Matt- oder Schwarzglas. Und dank seiner sage und schreibe fünf Breiten und sechs Höhen so frei konfigurierbar, dass es ideal zu Ihren Anforderungen passt.

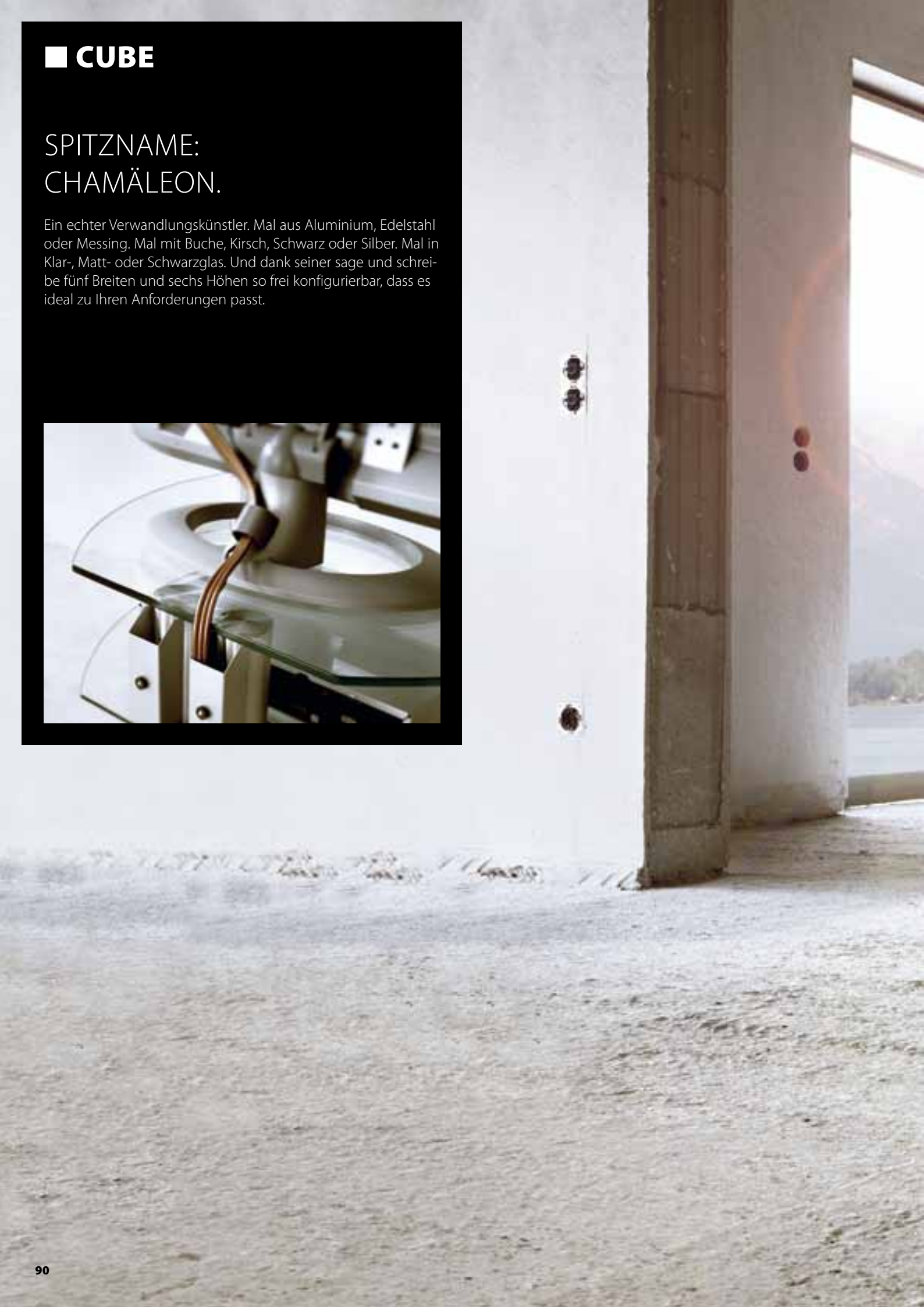



CUBE **CU2180-AL-Si**

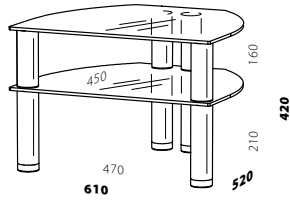

CUBE **CU2061**

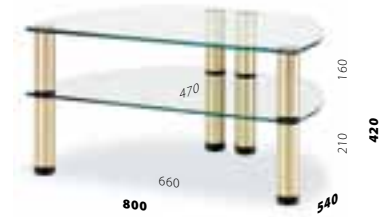

CUBE **CU2080-MS-S-KG**

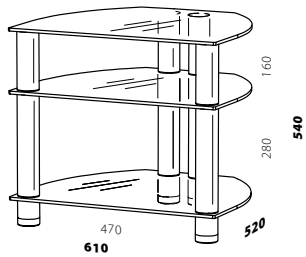

CUBE **CU2161**

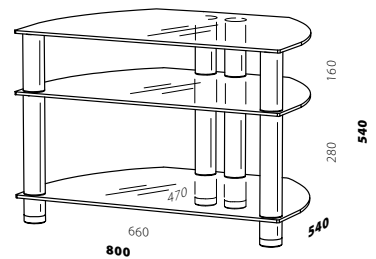

CUBE **CU2180**

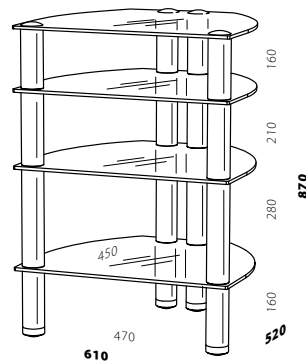

CUBE **CU204**

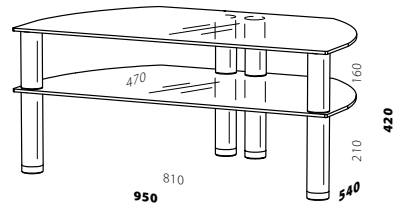

CUBE **CU2095**



CUBE **CU205-AL-S-BG**

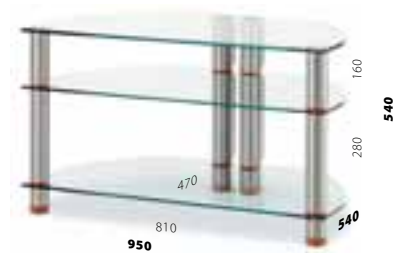

CUBE **CU2195-ES-K-KG**

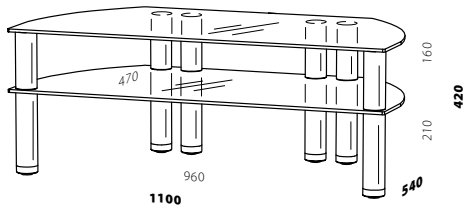

CUBE **CU20110**

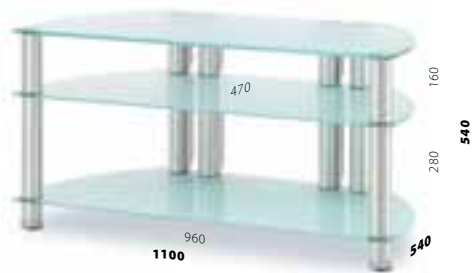

CUBE **CU21110-AL-Si-MG**



CUBE **CU21140-AL-S-KG**



Extra: Drehplatte  
**DP50** (610 mm breit)  
**DP5112** (800 mm breit)  
**DP5212** (950 mm breit)



Bei Edelstahl- und Messingsäulen:  
 Massivholzringe zwischen  
 Glas und Säule



Fuß mit Holzabschluss



Selbst montierbare Doppelrollen  
 (im Lieferumfang  
 enthalten)

- Säulen**  
 Aluminium (-AL)  
 Edelstahl (-ES)  
 Messing (-MS)

- Holz**  
 Buche (-B)  
 Kirsch (-K)  
 Schwarz (-S)

- Silber (-Si)

- Glasfarben**  
 Klar (-KG)  
 Matt (-MG)  
 Black (-BG)



So konfigurieren Sie  
 Ihr eigenes CUBE:

1. Modell wählen
2. Anzahl der Ebenen
3. Höhe der Ebenen
4. Säulen wählen
5. Holz wählen
6. Glasfarbe wählen
7. Extras
8. Skizze erstellen

Kabelführung bei  
 Individual-Modellen  
 mit Kabelspirale